

HYUNDAI
POWER PRODUCTS

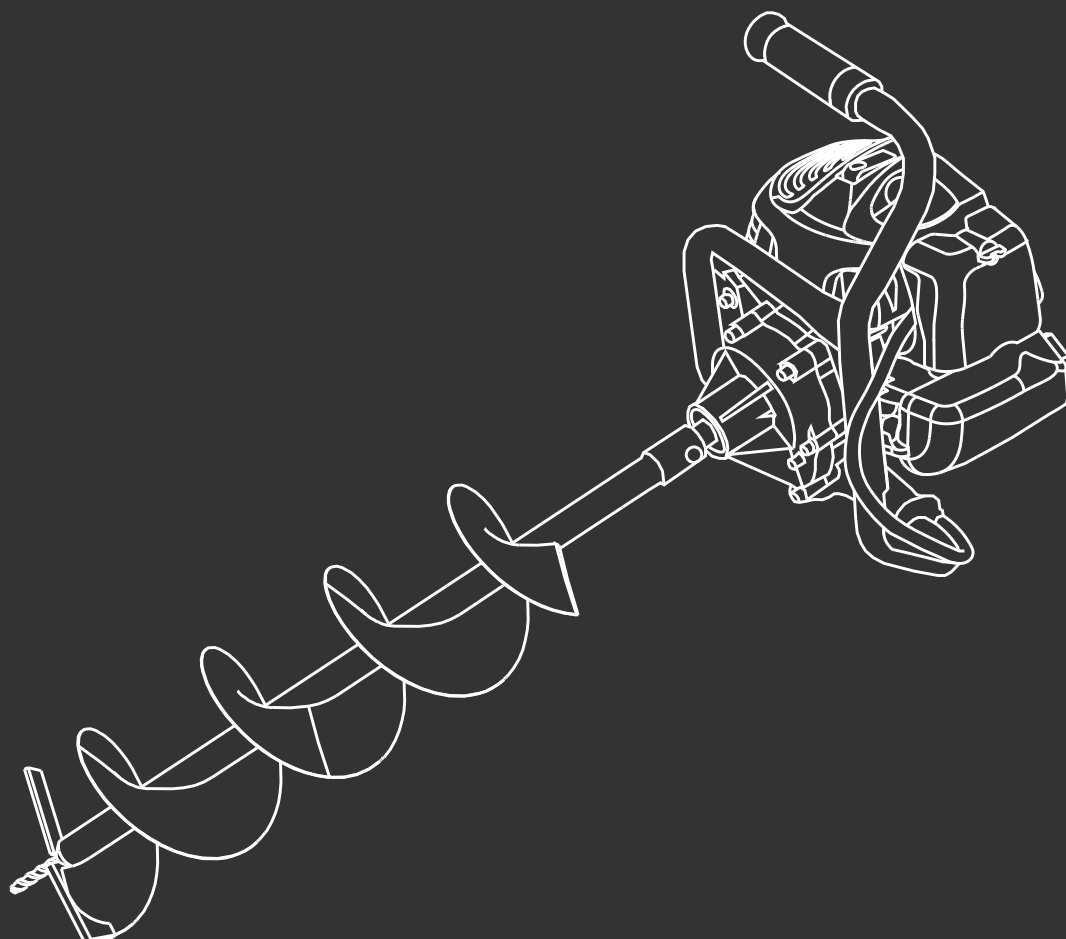

EARTH AUGER HYEA5200X

Instruction Manual



Introduction

Thank You For Purchasing Your HYUNDAI Product

We work very hard to give all of our customers the best possible service. If you have any problems, before leaving negative feedback, please contact us to give us a chance to resolve the issue. We would be delighted if you left us positive feedback! Thank you for purchasing this product.

Important!



⚠️WARNING : READ THE INSTRUCTION BOOKLET THOROUGHLY BEFORE USING THE MACHINE. Keep for future reference and pass it on if the machine is loaned or sold to another user.

This manual has been produced by Hyundai Power Products and should be kept with the product. Please read and understand these instructions before you use your product. Failure to do this may result in personal injury or damage to the product.

The safety precautions and warnings are to ensure your safety and protect you from harm or damage to the product.

The information contained in this manual was accurate at the time of production, however HYUNDAI Power Products may make modifications to the product without notification.

Contents

Features.....	4	Maintenance And Care.....	25-32
What's In The Box.....	4	Safety.....	25
Symbols On The Machine.....	5	Maintenance Schedule.....	26
General Safety	6-16	Checking Your Machine.....	27
Understand Your Machine.....	6	Repairs.....	27
Personal Safety.....	6-7	Cleaning.....	27
Inspect Your Machine.....	7-8	Spark Plug.....	28
Engine Safety.....	8	Cleaning & Replacing Air Filter.....	29
Work Area.....	9	Gear Box.....	29
During Use.....	9-11	Replacing Fuel Filter.....	30
Remaining Risks.....	11	Storage.....	30-31
Avoid Skin And Eye Contact.....	11	After Storage.....	31
Carbon Monoxide.....	12	Transportation And Handling.....	31
General Fuel Safety.....	12-13	Recycling And Disposal.....	32
Electrical Safety.....	14	Environmental Protection.....	32
Batteries.....	14	Spare Parts	33
Vibrations.....	14-15	Our Product Range	34
Noise.....	15	Useful Information	35
Intended Use.....	15	Our YouTube Channel.....	35
Personal Protective Equipment.....	16	Warranty.....	35
Getting Started	17	Manual Updates.....	35
Assembly Safety.....	17	Returning Your Product.....	35
Unboxing.....	17	Leaving A Review.....	35
Assembly	18	Ordering Spare Parts.....	35
Preparation	19	Notes	36-37
Mixing 2-Stroke Oil.....	19	Contact Us	38
Starting Procedure	20-21	Declaration Of Conformity	39
Stopping Procedure	22		
Troubleshooting	23		
Specifications	24		

Contact Us



www.hyundaipowerproducts.co.uk



01646 687 880



aftersales@hyundaipowerproducts.co.uk

Features

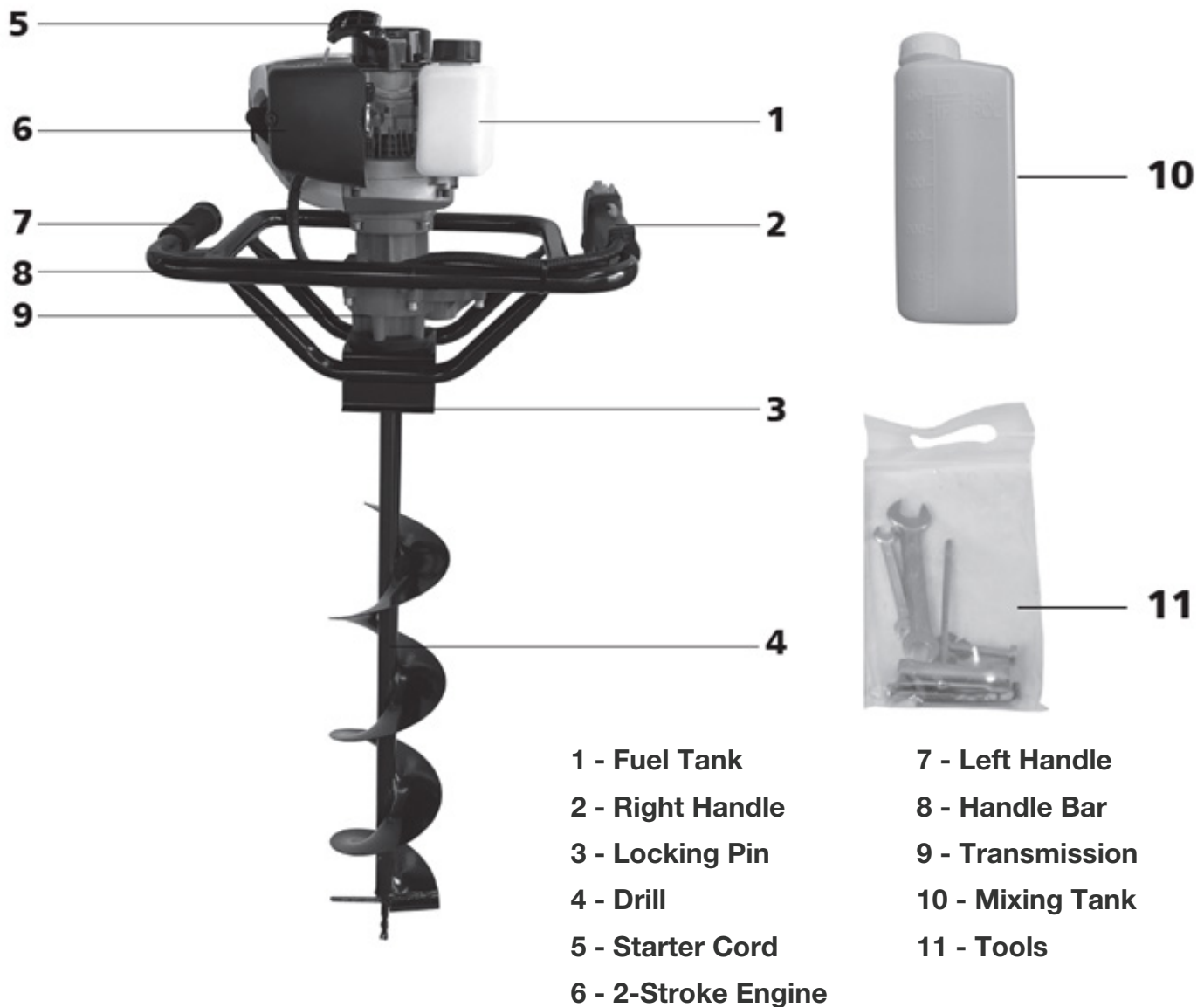









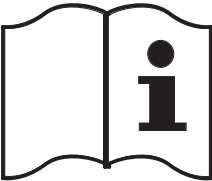

What's In The Box

- Earth Auger
- 100mm, 150mm, 200mm Drill Attachments
- User manual
- Tools
- Mixing Bottle

Symbols On The Machine

We have provided safety messages in this manual and on the lawnmower. This information alerts you to potential hazards that could hurt you or others. Please read these messages carefully. However, we may not have listed all of the possible hazards, you must also use your own judgment.

 <p>CAUTION! Handle carefully.</p>	 <p>HEARING PROTECTION MUST BE WORN Suitable safety hearing protection is recommended.</p>
 <p>INSTRUCTION MANUAL Read and understand operator's manual before using the machine. Failure to follow instructions could result in death or serious injury.</p>	 <p>DO NOT SMOKE Do not smoke, stay away from sparks, open flames, or other sources of ignition.</p>
 <p>CE SYMBOL This product complies with the applicable European directives and an evaluation method of conformity for these directives was done.</p>	 <p>DANGER! Keep feet away from drilling area.</p>
 <p>FOOT PROTECTION MUST BE WORN Non-skid heavy duty footwear is highly recommended when working.</p>	 <p>DANGER! Do not drill near underground cables or pipes.</p>
 <p>HAND PROTECTION MUST BE WORN Protective gloves are highly recommended when working.</p>	 <p>DANGER! Keep away from fire and do not smoke near this machine.</p>



General Safety



⚠ WARNING : READ THE INSTRUCTION BOOKLET THOROUGHLY BEFORE USING THE MACHINE. Keep for future reference and pass it on if the machine is loaned or sold to another user.

⚠ Understand Your Machine

- **WARNING!** You must read these instructions carefully before operating the machine. Make sure that you are familiar with the controls and properly operate the machine. You must learn how to stop the machine quickly. If you do not follow the warnings and instructions, it may result in fire and/or serious injury. Make sure to save all warnings and instructions for future reference.
- Read this manual and labels affixed to the machine to understand its limitations and potential hazards.
- Be thoroughly familiar with the controls and their proper operation. Know how to stop the machine and disengage the controls quickly.
- If the unit is to be used by someone other than original purchaser, or is to be loaned, rented, or sold, always provide this manual and any needed safety training before operation. The user can prevent and is responsible for accidents or injuries that may occur to themselves, to other people, or to property.
- Do not force the machine beyond its limits. Use the correct machine for your application.
- Know how to stop the engine quickly in case of emergency. Understand the use of all controls.
- ALL MAINTENANCE other than that listed in this manual, should be carried out by professionally trained and certified personnel.
- You must pass on safety notices to anyone working with the machine. They must read the manual before starting work. All safety and hazard notices must be observed.

⚠ Personal Safety

- **WARNING!** Never allow children or people unfamiliar with these instructions to use the product. Local regulations can restrict the minimum age of the operator.
- Keep children, pets, and other people not using the unit at least 23m (75 feet) away from the work area. Be alert and shut off the unit if anyone enters work area. Keep children under the watchful care of a responsible adult. If you are approached, stop the unit immediately.
- Stay alert, watch what you are doing and use common sense when operating the machine. Never operate the machine when unwell or tired, or if you have taken alcohol, medicine, drugs or any substances which may slow your reflexes and compromise judgement. A moment of inattention while operating the machine may result in serious personal injury.
- Appropriate Personal Protective Equipment (PPE), **MUST** be worn at all times when operating or repairing the machine. Always wear anti-slip and resistant work footwear and long trousers while using the machine. Do not use the machine when barefoot, wearing sandals or similar lightweight footwear. Do not wear chains, bracelets or clothing that is loose fitting or hanging ties or cords. Tie long hair back. Always wear protective earplugs. Loose clothes, jewellery, or long hair can be caught in moving parts. Protect eyes, face, and head from objects that may be thrown from the unit. Always wear safety goggles or safety glasses with side shields when operating.
- Always keep hands and feet away from all moving parts during operation. Moving parts can cut or crush body parts.

General Safety

- Always keep hands and feet away from all pinch points.
- Do not touch parts that might be hot from operation. Allow parts to cool before attempting to maintain, adjust, or service.
- Do not overreach. Keep proper footing and balance at all times. This enables better control of the machine in unexpected situations. Extending your body too far can result in a loss of balance and you may fall which will result in injury.
- Never place any part of your body where it would be in danger if movement should occur during assembly, installation, and operation, maintenance, repairing or moving.
- Start the engine carefully according to instructions and with feet away from the moving parts.
- Do not place your hands or feet near or under rotating parts. Keep away from any discharge openings.
- Keep in mind that the operator or user is responsible for accidents, hazards or unexpected events involving the machine that occur to other people or their property. It is the responsibility of the user to assess the potential risk of the area where work is being carried out. The operator or user must take all necessary precautions to ensure their own safety and that of others, especially on slopes or rough, slippery and unstable ground.
- The machine may only be used, maintained or repaired by people who are familiar with it and its dangers. Unauthorised changes to the machine negate the manufacturer's liability for damages resulting from this.
- The relevant accident prevention stipulations and other widely recognised safety rules must be observed.

- The manufacturer's stipulations concerning safety, work and maintenance as well as the measurements specified in Technical Data, must be complied with.

▲ Inspect Your Machine

- Check your machine before starting it. Keep guards in place and in working order. Make sure all nuts, bolts, etc., are securely tightened.
- You must check the general condition of the machine before use.
- Never operate the machine when it is in need of repair or is in poor mechanical condition. Replace damaged, missing, or failed parts before using it. Check for fuel leaks. Keep the machine in safe working condition.
- Do not use the machine if the engine's switch does not turn off the engine when running. Any petrol powered machine that can't be controlled with the engine switch is dangerous and must be replaced.
- Regularly check to see that keys and adjusting wrenches are removed from the machine area before starting it. A wrench or a key that is left attached to a rotating part of the machine may result in personal injury.
- Avoid accidental starting. Be sure the engine's switch is off before transporting the machine or performing any maintenance or service on the unit. Transporting or performing maintenance or service on a machine with its switch on invites accidents.
- If the machine should start to vibrate abnormally, stop the engine and check immediately for the cause. Vibration is generally a warning sign of trouble.
- Do not tamper with or disable safety systems.

Contact Us



General Safety

- Keep the machine in good operating condition. Operating a machine in poor or questionable condition could result in serious injury.
- Be sure all safety devices are in working order and warning labels are in place. These items are installed for your safety.
- All safety and hazard notices must be kept in completely legible condition.
- Only use manufacturer-recommended attachments.
- Before using, always visually inspect to see that the tools are not worn out or damaged. Replace worn out or damaged elements and bolts in set to preserve balance.
- Keep all nuts, bolts and screws tight to ensure the equipment is in safe working condition.
- The auger must not rotate in idling mode when the engine is warm.
- Do not tamper with the engine in an effort to get it to run at higher speeds. The maximum engine speed is preset by the manufacturer and is within safety limits.
- Keep a fire extinguisher on hand when operating this machine in dry areas as a precautionary measure.
- Never leave the operating position when the engine is running.
- The engine parts get very hot when running, do not touch. Danger of burns.
- Follow the instructions to ignite the engine carefully whilst keeping feet away from moving parts.
- Never incline the machine during ignition. Ignite the machine on a flat surface without obstacles or high grass.
- Do not over-rev the engine or change the engine settings.

⚠ Engine Safety

- This machine is equipped with an internal combustion engine. Do not use on, or near, forest-covered or brush-covered land unless the exhaust system is equipped with a spark arrester meeting applicable local, state, or federal laws.
- A spark arrester, if used, must be maintained in effective working order by the operator.
- Never start or run the engine inside a closed area. The exhaust fumes are dangerous, containing carbon monoxide, an odorless and deadly gas. Operate this unit only in a well-ventilated outdoor area. (See carbon monoxide safety).
- Never pick up or carry the machine while the engine is running.
- Stop the engine whenever you leave the machine, or before refuelling, when cleaning or while maintaining.
- Reduce the throttle setting during engine shut down and, if the engine is provided with a shut-off valve, turn the fuel off at the conclusion of working.
- Do not run the engine at a high speed when you are not using it.
- Keep the engine and exhaust free of grass, leaves, excessive grease or carbon build up to reduce the chance of a fire hazard.

General Safety

⚠ Work Area

- Make sure you thoroughly inspect the entire work area and remove all objects and anything that could be thrown by the machine or could damage the engine or machine (branches, stones, wire, toys, etc). Attempting to clear the work area whilst using the machine will reduce your concentration and creates a trip hazard. Any liquid spilled on the floor may result in you slipping.
- You must only work in daylight or with good artificial light in good visibility conditions. Keep people, children and animals away from the working area.
- Never place the machine in a place with unstable ground which could give way.
- You must pay special attention when approaching obstacles that could compromise visibility.
- Check the working environment for foreign bodies and remove them.
- Do not use where there is a risk of fire or explosion.
- Find and locate all fixed objects in the ground, such as sprinkler systems, poles, water valves, bases for washing lines etc. Make sure that you check for hidden electrical cables or similar on the surface of the ground. Make sure that the area to be drilled is free of all underground obstacles such as power cables, water and drainage pipes.
- You must be careful near ravines, ditches or embankments.
- Exercise extreme caution when operating on or crossing gravel drives, walks, or roads. Stay alert for hidden hazards or traffic.

- Do not work in the rain and when there is a thunderstorm or lightning risk. If there is bad weather conditions, do not use the machine.
- Avoid working on ground that is stony, hard or has many roots, strong recoil may occur at the handles.
- Be careful on unstable ground. Always ensure a safe standing position.
- During drilling, ejected rocks or pieces of wood can injure people and animals.
- Do not use the machine in a wet environment.
- Operate on a flat level ground. Never operate on slopes.

⚠ During Use

- Always hold the unit with both hands when operating. Keep a firm grip on the handlebars. Be aware that the machine may unexpectedly bounce upward or jump forward if the machine should strike buried obstacles such as large rocks or roots.
- Walk, never run with the machine.
- Use extreme caution when in reverse or pulling the machine towards you.
- Do not operate the machine in confined areas where there may be a risk of crushing the operator between the machine and another object.
- Be very careful when pulling the machine toward you. You must look behind you to make sure there are no obstacles before and during operations in reverse gear (if applicable).
- Before leaving the machine to clear blockages, check, clean, refuel or after striking foreign object, you must stop the engine.

Contact Us



General Safety

- **WARNING!** If something breaks or an accident happens whilst working, you must turn off the engine immediately and move the machine away to prevent further damage. If an accident happens with injuries or third parties are injured, carry out the first aid measures most suitable for the situation immediately and contact the medical authorities for any necessary health care. Carefully remove any debris that might cause damage or harm persons or animals should it not be seen.
- The excessive speed of movement or the absence of maintenance have a significant influence on noise emissions and vibrations. It is necessary to take preventive steps to eliminate possible damage due to high levels of noise and stress from vibration. You must maintain the machine well, wear ear protection and take breaks from working.
- Keep a firm hold on the handlebars with both hands when working.
- When leaving the machine, the engine must be switched off.
- Do not work by yourself, someone has to be close in case of emergencies.
- Do not lean too far forwards when working.
- Keep the earth auger vertical, do not twist it.
- Do not place the earth auger in dry grass or on flammable objects (fire risk).
- Immediately turn off the motor when you can feel changes to the machine's behaviour.
- Ensure you have a safe position, during the drilling process as well.
- You must only drill holes in soil.
- When leaving the earth auger, the engine must always be switched off.
- Always secure bore holes, otherwise there is a risk of injury.
- Drill the hole in the ground in several sections so you can remove the soil in between.
- The machine may only be used for its intended purpose. The user alone is responsible for unintended use of the machine. The manufacturer is not liable in the event of unintended use.
- People working with the machine must not be distracted.
- Only use the machine in a technically flawless condition, as well as for its intended purpose, in a safe manner and being aware of dangers, in compliance with the operating instructions. Disruptions which can affect safety in particular must be eliminated straight away.
- Do not touch rotating or hot parts.
- Do not smoke whilst using the machine.
- **WARNING** - The earth auger can catch clothes, string or wire and draw them in.
- Switch off the machine when not in use.
- Do not overload the appliance.
- Do not touch the exhaust when the engine is running (risk of burns).
- The auger drill bit is capable of causing serious injury so AT ALL times you MUST keep hands and feet clear of all moving parts. Failure to observe these safety instructions could result in serious injury or death.
- NEVER attempt to unclog either the auger drill bit while the engine is running. Immediately shut off the engine. Allow the auger drill bit to come to a complete stop.

General Safety

Remove the clogged material. Inspect for damage and check for any loose parts for repair or replacement.

- NEVER allow an accumulation of earth or drilled material to build up on the earth auger drill bit, this will prevent proper discharge from the hole and will make the auger heavy to handle.
- Whenever you leave the operating position or if you have to remove processed material, leaves or debris from the machine, You MUST always shut down the engine, disconnect spark plug HT lead, keeping them away from the spark plugs to prevent accidental starting, and wait for all moving parts to come to a complete stop.
- You MUST keep all combustible materials and substances away from the engine when it is hot.

⚠ Remaining Risks

The machine has been built according to the latest technology and recognised safety rules. However, there is still a chance of residual risks whilst working.

Furthermore, despite all measures taken, remaining risks can occur that are not obvious.

Remaining risks can be minimised by complying with the manual as well as the operating instructions overall.

⚠ Avoid Skin & Eye Contact

Mineral oil products degrease your skin. If your skin comes in contact with these substances repeatedly and for an extended period of time, it will desiccate. Various skin diseases may result. In addition, allergic reactions are known to occur.

Eyes can be irritated by contact with oil. If oil comes into your eyes, immediately wash them with clear water. If your eyes are still irritated, see a doctor immediately!

General Safety

⚠ Carbon Monoxide

 **DANGER** 

Engine exhaust fumes contain Carbon Monoxide. This is a poisonous gas and can kill in minutes. NEVER use inside a building or in an area with poor ventilation.

 **DANGER!**

CARBON MONOXIDE IS A COLOURLESS, ODOURLESS GAS. INHALING THIS GAS CAN CAUSE DEATH OR SERIOUS LONG-TERM HEALTH PROBLEMS SUCH AS BRAIN DAMAGE.

Never operate the engine in a confined space where dangerous carbon monoxide fumes can develop. All ignition operations have to be effected in an open or well-ventilated area. Always remember that exhaust fumes are toxic.

The symptoms of carbon monoxide poisoning can include but are not limited to the following; Headaches, dizziness, nausea, breathlessness, collapsing or loss of consciousness.

Carbon monoxide poisoning symptoms are similar to flu, food poisoning, viral infections and simply tiredness. It is quite common for people to mistake this very dangerous poisoning for something else.

To avoid carbon monoxide poisoning **DO NOT** use Petrol/Diesel powered equipment inside any of the following; Home, garage, tent, camper van, mobile home, caravan or boat. **DO NOT** use in an enclosed area or moving vehicle. This is not exhaustive and if you are in any doubt contact your dealer.

If you think you have or someone around you has been affected by carbon monoxide poisoning; Get them fresh air immediately,

by leaving the affected area or by opening doors and windows. If safe and practical to do so make sure that the machine is turned off. **DO NOT** enter a room you suspect of having carbon monoxide present – instead call the emergency services.

Contact a Doctor immediately or go to Hospital – let them know that you suspect carbon monoxide poisoning.

⚠ General Fuel Safety

 **CAUTION!**

ALL FUELS ARE HIGHLY FLAMMABLE AND PETROL VAPOUR IS EXPLOSIVE. TAKE EXTREME CARE WHEN HANDLING FUEL. KEEP FUEL OUT OF REACH OF CHILDREN.

General Safety

- Do not smoke each time fuel is handled.
- ALWAYS avoid inhaling fumes.
- ALWAYS carry fuel in the correct and clearly marked container.
- ALWAYS wear correct, suitable and fit for purpose Personal Protective Equipment (PPE), suggested items are but not limited to safety gloves, overalls.
- To avoid sparking or arcing, keep grounded conductive objects – such as tools – away from exposed, live electrical parts and connections. These events could ignite fumes or vapors.
- Do not operate the machine with known leaks in the fuel system.
- Fire hazard - keep fuel away from all sources of ignition for example heaters, lamps, sparks from grinding or welding.
- DO NOT carry out hot work on tanks that

General Safety

have contained fuel.

- ALWAYS keep the work area tidy.
- ALWAYS dispose of waste fuels correctly.

Spilled Fuel

- If you have spilled fuel, make sure you do not attempt to ignite the engine but move the machine away from the area of spilled fuel and avoid creating any source of ignition until the fuel has evaporated and fuel vapours have dissipated.
- When fuel is spilled on yourself or your clothes, wash your skin and change clothes immediately.
- ALWAYS clean up spills promptly using absorbent granules and a lidded bin.

Fueling / De-Fuelling

- ALWAYS fuel and de-fuel in a well ventilated area outside of buildings. Use a funnel to add fuel, only outdoors. Do not smoke during this and each time fuel is handled.
- Add fuel before igniting the engine, never remove the fuel tank cap or add fuel whilst the engine is running or when it is hot.
- When de-fueling ALWAYS use a proper fuel retriever.
- Never overfill the fuel tank. Because engine heat can cause fuel to expand, never fill the tank to more than 1/2" below the bottom of the filler neck. This will provide space for fuel expansion.

- When refilling or draining the fuel tank, use an approved fuel storage container while in a clean, well-ventilated outdoor area. While adding fuel or operating the unit, do not smoke, and stay away from sparks, open flames, or other sources of ignition near the area of operation.

- Always stop the engine and allow it to cool before filling the fuel tank. Never remove the cap of the fuel tank or add fuel while the engine is running or when the engine is hot.
- Loosen the fuel tank cap slowly to relieve any pressure in the tank.
- ALWAYS keep the handles dry, clean and free of oil and fuel.

Storage

- Make sure to store fuel in special containers.
- Store fuel in containers specifically designed and approved for fuel storage.
- Store fuel in a cool, well-ventilated area, safely away from sparks, open flames, or other sources of ignition.
- Never store fuel – or a machine with fuel in the tank – inside a building where fumes may reach a spark, open flame, or any other source of ignition (such as a water heater, furnace, or clothes dryer). Allow the engine to cool before storing in any enclosure.
- Replace all fuel tank and container caps securely and wipe up spilled fuel. Never operate the unit without the fuel cap securely in place.
- Fuels have a limited storage life. Aged fuel can cause starting problems and damage the engine. Purchase only the amount of fuel that you need.



General Safety

⚠ Electrical Safety



DANGER!

ELECTRICITY CAN KILL – NEVER WORK ON LIVE/ENERGISED EQUIPMENT.

- Prior to carrying out any maintenance work you **MUST** identify electrical isolation methods and isolate all electrical supplies.
- Prior to use and with all electrical supplies isolated, you **MUST** check all electrical cables, plugs and connectors for the following;
 - Are intact and have no signs of damage, to include but not limited to bare wires, chaffing, cuts and loose wiring.
 - If there are any signs of damage, the damaged item **MUST** be taken out of service until the damage has been repaired by an electrically competent person.
- All trailing cables should be routed so as not to cause any kind of trip hazard.
- **NEVER** work on or near electricity with wet hands, wet clothing and wet gloves.

⚠ Batteries

Batteries present a risk if they become damaged by the possible leaking of electrolyte. This electrolyte is an acid and can cause serious burn injuries. Care should be taken when working on or near them. **NOTE** the electrolyte may be in a liquid or gel form.

Should you come in to contact with electrolyte you should;

- Remove all clothing contaminated with electrolyte. If you cannot remove then saturate them in water.
- Get medical assistance as soon as possible.

You must advise the medical staff of the type of acid.

- Lead/acid battery = dilute sulphuric acid.
- Nickel/cadmium = potassium hydroxide alkali electrolyte.
- Use fresh running water to wash off excess electrolyte, continue this until medical assistance arrives. Make sure that you do not wash the electrolyte to another part of your body or face.
- If electrolyte comes in to contact with Eyes the electrolyte needs to be immediately washed away with large amounts of water. Make sure that you do not wash the electrolyte to another part of your face or body.
- Gasses from charging batteries are highly flammable and great care should be taken to charge in well ventilated areas.
-  There is an explosion risk if the battery terminals are short circuited, when connecting/disconnecting **ALWAYS** exercise great care so that the terminals or battery leads are **NOT** allowed to touch and cause a spark. **ALWAYS** use suitable insulated tools.

⚠ Vibrations

- Prolonged use of hand held (operated) machines will cause the user to feel the effects of/from vibrations. These vibrations can lead to white finger (Raynaud's phenomenon) or carpal tunnel syndrome. This condition reduces the ability of the hand to feel and regulate temperature, causing numbness and heat sensations and may cause nerve damage and circulatory tissue death.
- Not all factors that lead to white finger disease are known, but cold weather, smoking and other diseases that affect blood vessels

General Safety

and blood circulation as well as large and long-lasting impact of shocks are considered factors in the formation of white finger. Note the following to reduce the risk of white finger and carpal tunnel syndrome;

- Wear gloves and keep your hands warm.
- Take regular breaks.
- All of the above precautions may help reduce the risk of white finger disease but not rule out the carpal tunnel syndrome. Long-term and regular users are therefore recommended to observe the condition of your hands and fingers. Seek medical attention immediately if any of the above symptoms should occur.

Noise

- The operating noise of the machine can damage your hearing. Wear hearing protection such as earplugs or ear defenders to protect your hearing. Long-term and regular users are advised to have hearing checked regularly. Be especially vigilant and cautious when hearing ear protection because your ability to hear alarm warnings will be reduced.
- Noise emissions for this equipment is unavoidable. Carry out noisy work at approved times and for certain periods. Limit the working time to a minimum. For your personal protection and protection of people working nearby it is also advisable for them to wear hearing protection.



- See Certificate of Conformity section for Outdoor Noise declaration of conformity.

Intended Use

The HYE5200X is a petrol earth auger from Hyundai. The HYE5200X is powered by a 52cc 2-stroke petrol engine.

This machine is a garden tool and precisely a pedestrian controlled earth auger. The operator is able to operate the machine and use the main controls, always staying behind the handle.

The machine is manufactured according to the latest safety requirements. Every precaution is only effective when it is followed exactly.

Intended Use

The basic version of the equipment is an earth auger intended for private use, i.e. for use in home and gardening environments. It is designed for excavating planting holes, for perfolas and dences in light soil. It has only limited use on ground that is hard and stony and has many roots. The earth auger has been designed to be operated by one person.

User Types

This machine is intended for use by consumers, i.e. non professional operators. The machine is intended for “DIY” and domestic use only.

Improper Use

Any other usage not in keeping with the above mentioned ones may be hazardous and harm persons and/or damage things.

The equipment is allowed to be only used for its prescribed purpose. Any other use is deemed to be a case of misuse. The user/operator and not the manufacturer will be liable for any damage or injuries of any kind resulting from such misuse.



General Safety

▲ Personal Protective Equipment

Appropriate Personal Protective Equipment (PPE), **MUST** be worn at all times when operating or repairing the machine. No protective equipment can ensure 100% protection.

When selecting PPE, make sure it's CE marked and it suits the user in terms of size, fit etc. If more than one item of PPE is worn at the same time, make sure they can be used together, e.g. wearing safety glasses may disturb the seal of a respirator, causing air leaks.



HAND PROTECTION MUST BE WORN

Protective electrically non-conductive gloves are highly recommended when working.



FOOT PROTECTION MUST BE WORN

Non-skid heavy duty footwear are highly recommended when working.



HEARING PROTECTION MUST BE WORN

Suitable safety hearing protection is recommended.



EYE PROTECTION MUST BE WORN

Always wear safety glasses/goggles and/or face shields. Everyday eyeglasses have only impact resistant lenses; they are not safety glasses/goggles.



PROTECTIVE CLOTHING MUST BE WORN

Do not wear loose clothing, gloves, scarfs, neckties or jewellery (rings, wrist watches), which can be caught in moving parts.



HEAD PROTECTION MUST BE WORN

Wear a safety helmet with a safety visor.



FACE SHIELD MUST BE WORN

Wear a face shield to protect your face.



RESPIRATOR MUST BE WORN

Wear a respirator.

Getting Started

⚠ Assembly Safety

⚠ CAUTION - This guide is meant to serve as a quick reference for operating your HYUNDAI machine. We always advise reading the manual in full before operation.

⚠ CAUTION - For OUTDOOR use ONLY. Petrol machines produce carbon monoxide – a poisonous, colourless and odourless gas that can cause serious injury or death. Petrol is highly flammable, always handle with extreme care and in a well ventilated area.

⚠ NOTE - Images may vary depending on model.

⚠ NOTE - The machine can be supplied with some parts already assembled. Prior to assembly, check all items have been received.

⚠ NOTE - This machine is shipped without fuel and oil and MUST be filled before use. Failure to do so may cause damage to the engine that will not be covered by warranty.

⚠ IMPORTANT - For all work on the earth auger, you must turn off the engine, disconnect the spark plug connector and wear safety gloves. Start the auger only after complete assembly and checking it.

⚠ Unboxing Safety

⚠ WARNING! Unboxing and assembling the machine should be done on a flat, stable surface with enough room. Disposal of the packaging should be done in accordance with the local regulations in force.

Carefully remove the product from the packaging and examine it for any sign of damage caused during shipping. Lay the contents out and check them. If any part is damaged or missing, you must not use the machine. Contact HYUNDAI Power Products immediately. You must keep the packaging material in case the machine needs to be returned or repaired.

⚠ WARNING! Some of the packaging material may be harmful to children. Keep out of reach of children.

As soon as you have purchased your machine, we recommend that you fill out the information on page 38. If you need to contact an authorised dealer or customer service for information on servicing, you may need to provide this information.

Assembly

Unboxing & Assembly Video:

Go to youtube.com and type in Hyundai HYE5200X assembly.

YOU MUST read and understand the instruction manual first.

Inserting The Earth Auger

STEP 1

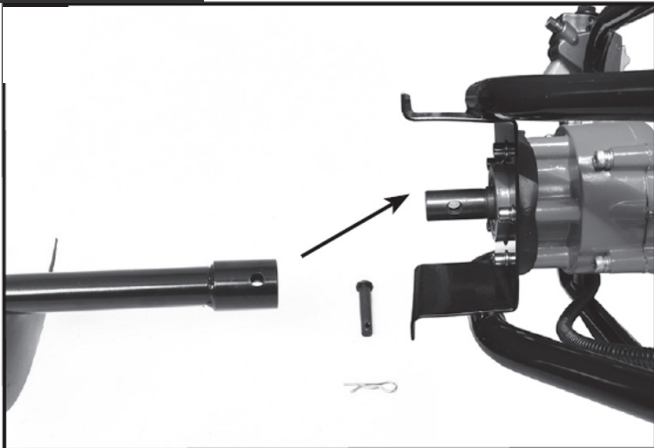

Place the motor casing on a work bench.
Place the earth auger on the drive shaft,
ensuring that both holes are aligned.

STEP 2



Insert the drive pin. Secure with R-pin.

Preparation

Mixing 2-Stroke Oil

Fuel Type : Use fresh unleaded petrol mixed 40:1 with semi-synthetic 2-stroke oil or aspen2 pre-mixed fuel.

Fuel Capacity : 1000ml

 **CAUTION - ALL FUELS ARE FLAMMABLE**

- **ALWAYS** fuel and defuel in a well ventilated area outside of buildings with the engine switched off. Allow the engine to cool down before refueling.
- **ALWAYS** wear correct, suitable and fit for purpose Personal Protective Equipment (PPE), suggested items are but not limited to safety gloves, overalls.
- **NEVER** refuel the machine in a building where the petrol fumes can reach flames or sparks.
- Petrol is highly flammable and explosive.
- Never refuel when the engine is still hot or running.

STEP 1

Fill the mixing bottle with the correct amount of fresh unleaded petrol. DO NOT mix the fuel mixture in the fuel tank. You MUST only use fresh unleaded petrol and 2 stroke engine oil mixture.

For the first time ONLY a mixing ratio of 25:1 should be used to lubricate all engine parts to an optimum level. After this, the mix is 40:1.

STEP 2

Mix the fuel/oil mixture.

STEP 3

Unscrew the fuel tank cap and carefully add the fuel / 2-stroke oil mixture as in the step above. Only pour the fuel mixture into the fuel tank after you have mixed and stirred it.

DO NOT overfill and allow a 25mm gap at the top of the tank. DO NOT use straight unleaded petrol. Clean up any spills immediately. Clean the area around the cap, to prevent dirt from getting into the fuel or oil tank.

STEP 4

Once full replace and correctly tighten the fuel cap. Clean up any fuel spilt before starting the engine.

Petrol	Semi-Synthetic 2-Stroke Oil
2L	50ml
3L	75ml
4L	100ml
Method of mixing	40 parts petrol + 1 part 2-stroke oil

 **NOTE**

- Do not add more 2-stroke oil than specified to ensure safe operation. This will only result in a higher production of combustion residues which will pollute the environment and clog the exhaust channel in the cylinder as well as the muffler. In addition, fuel consumption will rise and performance will decrease.



Starting Procedure

⚠ CAUTION - For OUTDOOR use ONLY. Petrol machines produce carbon monoxide – a poisonous, colourless and odourless gas that can cause serious injury or death. Petrol is highly flammable, always handle with extreme care and in a well ventilated area.

⚠ NOTE - This machine is shipped without fuel and oil mixture and MUST be filled before use. Failure to do so may cause damage to the engine that will not be covered by warranty.

⚠ CAUTION! ALL FUELS ARE FLAMMABLE
Always fuel and de-fuel in a well ventilated area away from sources of ignition. Move the machine at least 3m away from the refuelling point before starting.

⚠ WARNING - If you are not familiar with this type of machine, you should seek advice and guidance from your dealer.

⚠ WARNING - You MUST STOP using the machine if any of the following occur:

- The engine speed changes with no control
- In case of misfire
- In case of high vibration
- When flames or smoke appear
- In rain or stormy weather

Before Each Use

• Always ensure that the machine is in a safe working condition. Inspect the machine, check safety devices, the condition of the fuel lines and check all nuts, bolts and screws are secure. Make sure that the earth auger can move freely.

- Check the fuel / 2-stroke oil mixture. Go to page 19 for more information.
- Before starting, make sure the machine is clear of all materials and non-essential people.
- Make sure you know how to stop the engine before starting.

⚠ CAUTION

- Always start slowly with half throttle and keep a firm grip on both handles of the auger at all times. Keep a wide stance.
- After engine warms up, accelerate the engine. To accelerate the engine to working speed, squeeze the throttle lever toward the main handle.
- Do not force the auger drill bit into the ground - instead allow the machine to do the work. If the machine jams you MUST release the throttle and move the auger drill bit before re-commencing work.
- To remove blockages DO NOT under any circumstance use your hands. STOP and disable the machine and clear the auger drill bit of materials which have become stuck to the auger bit.

Starting Procedure

STEP 1



If the engine is cold, move the choke lever (A) to the START position. The choke lever opens and closes the choke in the carburettor.

If the engine is warm, leave the choke lever to the RUN position.

Starting Procedure

STEP 2



2 Prime the fuel pump (B) by pressing primer bulb several times until you can see fuel in the bulb and pipes.

STEP 3

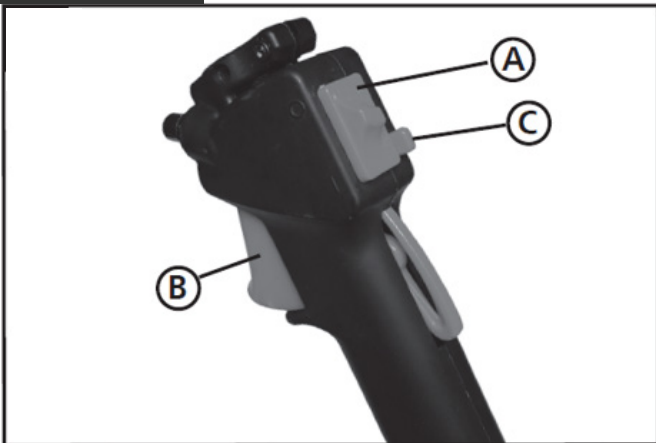

Put the stop switch (A) into the start position.

STEP 4

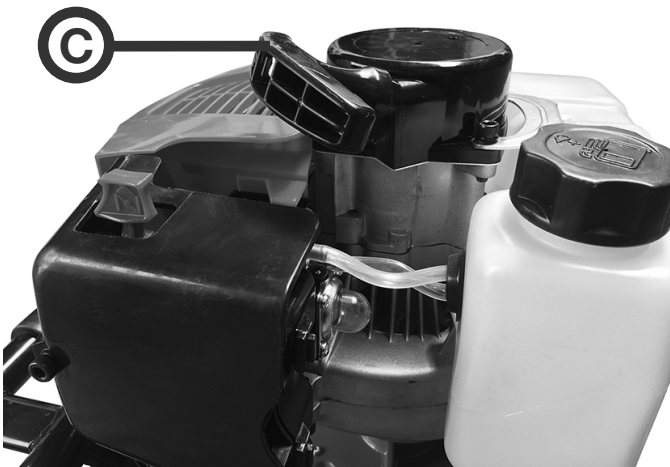

4 Lightly pull on the starter cord (C) until you can feel resistance, then pull on the cord quickly and firmly until the engine starts.

⚠ CAUTION - Do not pull out the starter cord more than approx. 50cm, and let it recoil slowly by hand. For efficient starting, it is important to pull the starter cable quickly and powerfully.

STEP 5



After running for 10 seconds or so, squeeze the throttle trigger to release the choke lever (A) to the RUN position.

⚠ WARNING - The earth auger only begins to rotate when the throttle lever is used.

Stopping Procedure

⚠ CAUTION - The engine and exhaust will remain hot for a while after use. Ensure the engine and exhaust has cooled before carrying out any maintenance, refuelling or storage.

After Each Use

- Examine the machine for damage.
- Clean the machine if necessary, go to page 27 for more information on how to clean your machine.

Stopping Procedure

STEP 1

Before stopping the machine, allow the engine to cool down for a few minutes, by allowing it to run without throttle.

STEP 2

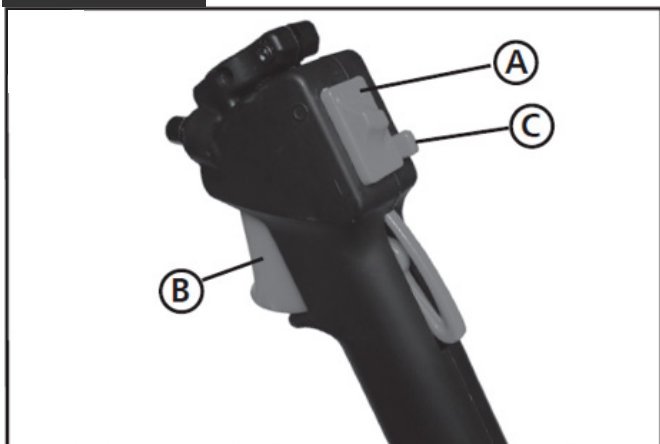

Put the stop switch (A) into the stop position.

Troubleshooting

Problem	Possible Cause	Possible Solution
Starting difficulty - no spark	<ol style="list-style-type: none"> 1. Carbon deposit between electrodes of the spark plug. 2. Defective ignition coil, flywheel magneto too weak. 	<ol style="list-style-type: none"> 1. Clean the spark plug. Adjust the gap to 0.6~0.7mm. Replace the spark plug. 2. Replace the ignition coil or the flywheel.
Starting difficulty - weak spark	<ol style="list-style-type: none"> 1. Too much fuel in the combustion chamber, poor fuel or water in tank. 2. Blocked fuel line. 	<ol style="list-style-type: none"> 1. Remove spark plug and dry, replace fuel. 2. Clean the carburettor and fuel lines.
Starting difficulty - normal fuel - but weak compression	<ol style="list-style-type: none"> 1. Worn piston rings, spark plug not tightened. 	<ol style="list-style-type: none"> 1. Replace and adjust as required.
Difficulties during use <ol style="list-style-type: none"> 1. Motor does not come up to speed. 2. Runs out of power 3. Noisy engine 4. Leaking carburettor 	<ol style="list-style-type: none"> 1. Choke is in 'cold start' position, exhaust blocked, weak spark, valve clearance too large. 2. Blocked fuel lines, incorrect spark plug gap. 3. Incorrect choke position, damage to crank shaft. 4. Failure of the fuel tank non-return valve, worn carburettor gasket. 	<ol style="list-style-type: none"> 1. Open choke, clear exhaust, check or replace ignition coil and flywheel, adjust valve clearance. 2. Clear or replace fuel lines, adjust spark plug gap. 3. Adjust choke lever position - replace crankshaft. 4. Replace fuel cap - replace gasket or carburettor as required.

 **NOTE-** If troubleshooting does not solve the problem, contact your dealer or the manufacturer directly. Use only original parts approved by the manufacturer, otherwise a hazard risk arises.

Specifications

NOTE - All machines are tested and inspected so there may be some residual oil left in the machine so please fill with caution.

Model	HYEA5200X
Engine Type	2-Stroke Air-Cooled
Engine Size	51.7cc
Max. Engine Power At 9600rpm	1.45kW / 2hp
Max. Working Engine Speed	9600rpm
Diameter Of Drill	100mm / 150mm / 200mm
Depth Of Drilling	730mm
Fuel Type	40:1 Unleaded Petrol and Semi-Synthetic 2-Stroke Oil
Fuel Tank Capacity	1000ml
Measured Noise Level	LwA = 106.28dB (A) ; K = 1.52dB (A)
Guaranteed Noise Level	107dB(A)
Vibrations At Handles	18.8m/s ² K = 1.5m/s ²
Vibrations At Handles In Idle Speed	11.4m/s ² K = 1.5m/s ²
Operating Conditions	0 °C. - + 32°C
Net Weight	13kg (with 100mm drill)
Dimensions (L x W x H)	1040 x 590 x 420mm

Specifications are subject to change without notice.

Maintenance & Care

Maintenance Safety

 **IMPORTANT** - Routine and accurate maintenance is essential for maintaining original machine safety and performance levels.

 **WARNING** - Before cleaning or doing maintenance work, you need to stop the engine, disconnect the spark plug cable and read the relevant instructions. You need to wear proper clothing and protective gloves whenever your hands are at risk.

 If there are worn or damaged parts, never use the machine. Faulty or worn-out parts must be replaced and not repaired. You must only use original spare parts. The use of non-original and/or incorrectly fitted parts will jeopardize the safety of the machine. This may also cause accidents or personal injuries for which the manufacturer is under no circumstance liable or responsible.

 Any maintenance operations or adjustments not explained in this manual must be carried out by your Dealer or a specialised Service Centre with the necessary knowledge and equipment to ensure that the work is done correctly maintaining the machine's original safety level. Any operations performed in unauthorised centres or by unqualified persons will invalidate the Warranty and all obligations and responsibilities of the Manufacturer.

 Be very careful during adjustment of the machine to prevent entrapment of the fingers between moving and fixed parts of the machine.

 **CAUTION - DO NOT** use a hose pipe or pressure washer to clean the engine. Water can damage the engine or contaminate the fuel system.

 All protective and safety equipment must be re-attached immediately after completing repairs and maintenance. The machine's safety devices must not be removed or made unstable.

 Only use appliances which are in perfect working order.

 You must service the appliance whenever necessary.

 Installations, repairs and maintenance must be carried out by a specialist.

 Position the machine in such a way that it cannot move during use, maintenance, cleaning, adjustment, assembly of accessories or spare parts, as well as under storage.



Maintenance & Care

Maintenance Schedule

	Before Each Use	After Each Use	After 20 Hours	After 100 Hours	After 300 Hours
Check Machine. <i>See page 27.</i>	X	X			
Air Filter. <i>See page 29.</i>			Clean	Replace*	
Spark Plug. <i>See page 28.</i>			Check	Replace	
Fuel Filter. <i>See page 30.</i>		X			
Gear Box. <i>See page 29.</i>			Check		
Cooling Fins.			Check		
Mechanical Connections.			Check		
Fuel Tank.			Check		
Fuel Pipes.			Check		

* Increase maintenance interval if operating in dusty environment.

Maintenance & Care

Checking Your Machine

When checking your machine, we recommend you :

- Check for worn or damaged parts.
- Make sure all nuts, screws and bolts are tight.
- Make sure all warning stickers are in place and not damaged.
- Check for oil / fuel leaks.
- Check fuel tank, fuel lines and fuel cap for leakages or tears, do not start the machine with such damage.
- Check exhaust cover and the air filter cover.
- Check the position of the auger and functioning of the operating elements.

Repairs

If you need to send your earth auger to be repaired, please note that for safety reasons, it must be delivered free from oil and petrol.

Cleaning

 **CAUTION - DO NOT** use a hose pipe or pressure washer to clean the engine. Water can damage the engine or contaminate the fuel system.

 **NOTE** Engine must be switched off and spark plug lead disconnected.

 **NEVER** pour or squirt the unit with water or any other liquid. Keep handles dry, clean and free from debris.

After Each Use

- You must remove grass and mud from the machine to prevent it from drying. This will cause problems the next time the it is used.
- Wipe the machine down with a damp cloth.
- For larger build ups of debris, use a scraper or similar product.
- Dry the machine completely to prevent rust from forming.
- Make sure not to drip petrol onto the plastic parts to prevent damaging them and remove all traces of spilt petrol immediately. The warranty will not cover damage to plastic parts caused by petrol.
- Avoid using solvents when cleaning plastic parts. Most plastics are susceptible to damage from various types of commercial solvents and may be damaged by their use. Ensure that no water can seep into the machine.

Regularly

- Use a light silicone spray on exposed metal parts to protect the metal.

Contact Us



Maintenance & Care

The Spark Plug

STEP 1

You **MUST** allow the engine to cool down before carrying out any maintenance.

Do not touch the spark plug when the machine is running (risk of electric shock).

STEP 2

Always replace with the same model spark plug as fitted.

STEP 3

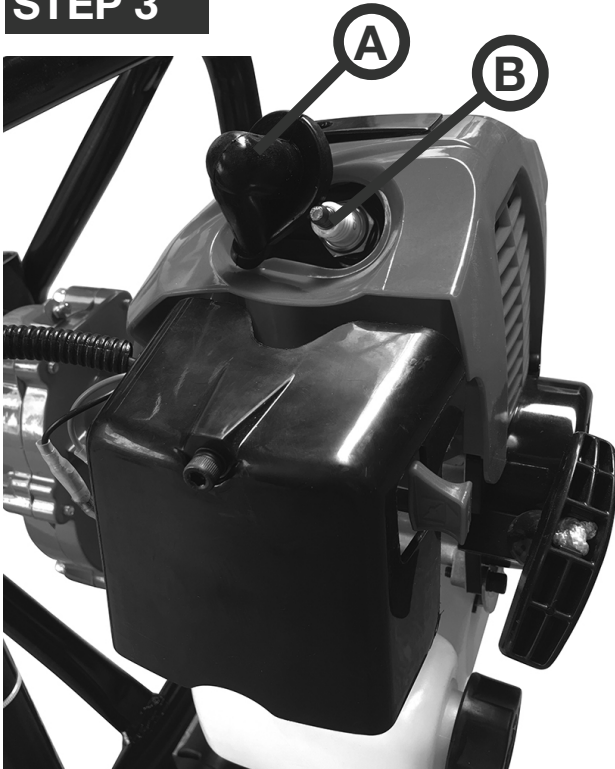

Remove the spark plug cover (A) by removing the screw (B) with the provided key.

STEP 4

Visually inspect the spark plug for signs of damage, wear or carbon build up. Check the insulator for damage such as cracks or chips. If damaged or worn, replace immediately.

STEP 5

To clean the spark plug, gently clean the electrode with a soft wire brush.

STEP 6

The spark plug gap should be 0.70mm to 0.80mm. Check the gap by using a feeler gauge. Adjust as necessary by carefully bending the side electrode to achieve the correct gap.

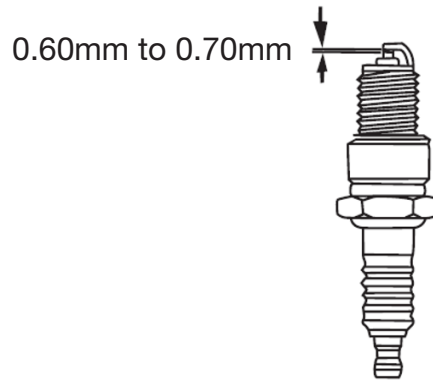

STEP 7

Refit the cleaned and adjusted spark plug by hand to avoid cross-threading.

STEP 8

Tighten as necessary with a spark plug wrench but avoid over-tightening.

STEP 9

Re-attach the spark plug cover.

⚠ NOTE

Ensure that no dirt gets into the cylinder head during replacement.

Check the position of the spark plug.

- A loose spark plug can damage the engine by overheating.
- Tightening it too much can damage the thread in the cylinder head.

Maintenance & Care

Air Filter

⚠ CAUTION - A dirty air filter will restrict the air flow to the carburettor, which will reduce engine efficiency.

When using the earth auger in very dusty areas you must clean or replace the air filter more often. Never operate the machine without the air filter being fitted it can cause damage to the engine which is not covered by warranty.

STEP 1



Loosen the screw on the air filter casing. Remove the air filter cover and check it.

STEP 2



Carefully remove the foam filter insert and check it for damage. Replace if required.

Clean the foam insert in warm water with a mild soap solution. Thoroughly rinse it with clear water and leave it to dry.

STEP 3



Clean dirt from the inside of the filter casing with a clean, damp cloth.

STEP 3

Return the foam filter insert and reposition the air filter casing.

Do not run the engine without an air filter insert or when it is damaged. This can cause damage which is not covered by your warranty.

Gearbox

- Use a high temperature gearbox grease. Such as Morris K323 Premium blue grease or equivalent.
 - Check the gear box grease every 20 hours of use and fill as required. Thereafter check and top-up after every 25 hours. N.B. 20 grams is sufficient for a full top-up.
 - To fill with or top-up with grease apply grease with a grease gun to the grease nipple.
 - Recommended change interval. 1st check after 20 hours of use. Thereafter every 25 hours of use.
- ⚠ If you do not follow these steps, deposit may arise in the carburettor. This will cause starting difficulties and may cause permanent damage.**

Contact Us



www.hyundaipowerproducts.co.uk



01646 687 880



aftersales@hyundaipowerproducts.co.uk

Maintenance & Care

Replacing Fuel Filter

The fuel filter can become clogged. It is recommended to replace the fuel filter once every 100 hours in order to ensure sufficient fuel flow to the carburettor.

To remove the fuel filter for replacement, pull it out through the tank filler neck using a piece of wire bent at one end to form a hook.



Pull old filter from fuel pipe and replace with new filter.

Storage

⚠ CAUTION - When storing the machine, make sure it has been cleaned properly. See cleaning section.

NOTE - If storing the machine for a period of 30 days or more, you must follow proper storage and winterisation guidelines to avoid any possible issues with your machine. Incorrect storage can lead to possible fueling or engine issues that will not be covered by the warranty.

The following steps should be taken to prepare your machine for storage. Unless the storage instructions are followed, fuel remaining in the carburettor will evaporate, leaving gum-like deposits. This could lead to difficult starting and result in costly repairs.

1. Remove the fuel tank cap slowly to release any pressure in the tank. Drain all the fuel from the fuel tank and then run the machine until it has completely run out of fuel.
2. Allow the engine to cool.
3. Follow the cleaning instructions as set out in the cleaning section and make sure all moving parts are lubricated with a light silicone based spray or grease.
4. Follow the maintenance section and check, service or replace serviceable items if required.
5. Remove the spark plug and pour 1 teaspoon of clean 2-cycle oil into the combustion chamber. Pull starter rope slowly several times to coat internal components.
6. Refit the spark plug.
7. Visually inspect the machine and replace or repair any worn parts.

Maintenance & Care

8. Once all work above is carried out store the machine in a clean, cool and dry place away from sources of ignition and varying changes in temperature. DO NOT store a machine that has not been given time to fully cool down. Store away from potential sources of ignition, such as furnaces, hot water boilers with gas, etc.

You must follow these guidelines for storage:

 Store in a cool, dry place away from sources of ignition and varying changes in temperature.

 DO NOT store a machine that has not been given time to fully cool down. Engine must be cooled down fully before storage.

 DO NOT stack other items on top of the machine when in storage.

 DO NOT store the machine with fuel in the tank in an area where the fuel vapours could reach an open flame, a strong heat source or a spark.

 Store the machine in a safe place, out of the reach of children.

 Store the machine safely so that nobody can get injured by the machine or put it into operation.

After Storage

1. Remove spark plug
2. Pull starter rope briskly to clear excess oil from combustion chamber.
3. Clean the spark plug and check that the electrode gap is correct.
4. Prepare unit for operation.
5. Fill fuel tank with proper fuel/oil mixture.

Transportation & Handling

1. Whenever the machine is to be handled, lifted, transported or tilted you must:
 - Wear sturdy work gloves
 - Hold the machine at the points that offer a safe grip, taking into account the weight and relative distribution of the same
 - Use an appropriate number of people for the weight of the machine and the characteristics of the vehicle or the place where it must be placed or collected
 - You must make sure that machine movements do not cause fuel leaks, damage or injuries.
2. During transport, make sure to fasten the machine securely with cables or straps.
3. Leave the machine to cool down before transporting.
4. Turn off the engine even for short distances.
5. The fuel tank must be emptied completely before transport.

Maintenance & Care

Recycling And Disposal



We do not offer a takeback scheme for the recovery of Waste Electrical Electronic Equipment (WEEE) & Batteries. Instead the responsibility to dispose of WEEE and or Batteries is passed onto you by us.

So when it becomes necessary to dispose of your machine you must take it to your local Civic Amenity Site. For further information please contact your local Authority for disposal advice.

You **MUST** make sure that all unused oil and fuel is disposed of correctly either beforehand or at your local Civic Amenity Site.

Under NO circumstances must any fuel or oil be put down any drains.

Certain products contain WEEE waste which should not be disposed of in your domestic waste.

You **MUST** recycle WEEE in accordance with your local authority or recycling centre.

Certain products contain batteries which should not be disposed of in your domestic waste.

You **MUST** recycle batteries in accordance with your local authority or recycling centre.

Unwanted packaging and materials should be stored and taken to a recycling centre so it can be disposed of in a manner which is compatible with the environment.

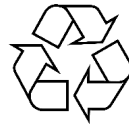

This symbol means you should 'Reduce - Reuse - Recycle'

We are a Member of the VALPAK National Compliance Scheme and our registration number is **RM08660**

For further information about disposal please contact your Local Authority.

You can also get more advice and guidance about recycling at the following website <http://www.recycle-more.co.uk>

Should you pass this product on to another user either sold or loaned, you **MUST** pass on this user manual. This will make sure that all other users can use and maintain this machine safely.

Environmental Protection

1. Environmental protection should be a priority of considerable importance when using the machine, for the benefit of both social coexistence and the environment in which we live. Try not to cause any disturbance to the surrounding area.
2. You must comply with local regulations and provisions for the disposal of packaging, oils, petrol, filters, damaged parts or any elements which have a strong impact on the environment. This waste must not be disposed of as normal waste. It needs to be separated and taken to specified waste disposal centres where the material will be recycled.
3. You must comply with local regulations for the disposal of waste materials after mowing.
4. When disposing, do not pollute the environment with the machine, but hand it over to a disposal centre, in accordance with the local laws in force.

Spare Parts

Only use original spare parts: The use of non-original and/or incorrectly fitted parts will jeopardize the safety of the machine, may cause accidents or personal injuries for which the Manufacturer is under no circumstance liable or responsible.

Part	Part Number
Spark Plug	HYEA5200XSPARKPLUG
Recoil Start	HYEA5200XRECOIL
Air Filter	HYEA5200XAIRFILTER
Fuel Filter	HYEA5200XFUELFILTER

Our Product Range

Generators

Leisure Inverter, Petrol, Diesel And Built-In Motorhome Generators

Pressure Washers

Petrol, Diesel And Electric Pressure Washers

Water Pumps

Submersible, Clean And Dirty Water And Professional Chemical Water Pumps

Lawnmowers

Petrol, Cordless, Electric, Roller, Self Propelled, Robotic And Electric Start Lawnmowers

Grass Trimmers And Brushcutters

Petrol, Cordless And Wheeled Grass Trimmers And Brushcutters

Chainsaws

Petrol, Cordless And Electric Chainsaws

Hedge Trimmers

Petrol And Cordless Hedge Trimmers

Leaf Blowers

Petrol, Electric, Cordless, Backpack And 3 -in-1 Leaf Blowers

Log Splitters

Horizontal, Vertical, Petrol And Electric Log Splitters

Wood Chippers

Petrol And Electric Start Wood Chippers

Tillers

Petrol Garden Tiller And Cultivator

Earth Augers And Trenchers

Petrol Earth Augers And Heavy Duty Trenchers

Compactor Plates

Petrol Compactor Plates

Cement Mixers

Portable Electric Cement Mixers

Mini Dumpers

4-Wheel Drive Mini Dumper / Power Barrow

Yard Sweeper

Self Propelled Yard Sweeper Power Brush

Scarifiers

Petrol Lawn Scarifier And Aerator

Stump Grinders

Petrol 4-Stroke Stump Grinders

Welders And Plasma Cutters

MIG, TIG, MMA, ARC Welders And Plasma Cutters

Power Tools And Tool Chests

Electric And Cordless Power Tools And Caster Mounted Tool Chests

Vacuum Cleaners

Wet And Dry Vacuum Cleaners

Engines

Petrol And Electric Start Engines

Battery Chargers / Starters

6V, 12V, 24V Battery Chargers, Jump Starters And Hydraulic Floor Jack

Air Compressors

Home, Domestic, DIY And Professional Use Air Compressors

Lighting Towers

Mobile Lighting Towers With Diesel Generators

And More

We Are Constantly Expanding Our Range With New Products

If you would like more information on any of these products, please contact our sales team on 01646 687880 or visit our website www.hyundaipowerproducts.co.uk

Useful Information

Check Out Our YouTube Channel

Our videos on YouTube include:

- Unboxing
- Assembly of your machine
- How to service your machine
- Products in use
- 'How To' videos
- Product features

Go to www.hyundaisupport.co.uk or search 'Hyundai Power Products' in YouTube.

Warranty

Proof of purchase will be required before you make a warranty claim.

Full warranty terms and conditions can be found on the HYUNDAI POWER PRODUCTS website: www.hyundaipowerproducts.co.uk

Manual Updates

Our manuals are constantly being reviewed and updated. Should you find an error, omission or something unclear, please contact us for assistance.

We reserve the right to make any modifications without prior notice whenever necessary.

Our latest manuals are also placed online.

All our manuals can be downloaded at: www.hyundaipowerproducts.co.uk

Returning Your Product

If you are returning your product, please contact the dealer for their returns policy.

Leaving A Review

We work very hard to give all of our customers the best possible service. If you have any problems, before leaving negative feedback, please contact us to give us a chance to resolve the issue. We would be delighted if you left us positive feedback!

To leave a review, please go to: uk.trustpilot.com/review/hyundaipowerequipment.co.uk

Ordering Spare Parts

Only use original spare parts: The use of non-original and/or incorrectly fitted parts will jeopardize the safety of the machine, may cause accidents or personal injuries for which the Manufacturer is under no circumstance liable or responsible.

Contact Us



Need Help? Talk To Our Experts

Contact Us

Our friendly aftersales team will be more than happy to help you.

Phone

Call our team on 01646 687880, open Monday-Friday 8.30am-5pm.

Email

aftersales@hyundaipowerproducts.co.uk

Online Live Chat

Go to www.hyundaipowerproducts.co.uk

Live chat is open Monday-Friday from 8.30am-5pm.

Post

Genpower Limited, Isaac Way, Pembroke Dock, Pembrokeshire, SA72 4RW, UK.

As soon as you have purchased the machine, we recommend that you fill out the following. If you need to contact an authorised dealer or customer service for information on servicing, you may need to provide the following information.

The model number and serial number can be found on the grey specification sticker on the machine.

Date Of Purchase:

Dealer Name:.....

Dealer Phone:.....

Model Number:.....

Serial Number:.....

Declaration Of Conformity

EC Declaration of Conformity

We hereby declare that the machine detailed in this declaration complies to all the relevant provisions of the following EC directives.

- 2006/42/EC The Machinery Directive
- 2014/30/EU Annex II Electromagnetic Compatibility Directive
- 2016/1628/EC The Emission of Gaseous and Particulate Pollutants from internal Combustion engines
- 2000/14/EC Noise Emissions in the Environment by Equipment for use Outdoors.

And is in conformity with the applicable requirements of the following documents:

- EN ISO 11806-1:2011
- EN ISO 10517:2019

Declaration for 2000/14/EC Noise Emissions in the Environment by Equipment for use Outdoors.
Notified Body for EC Directive 2000/14/EC TÜV Rheinland (Shanghai) Co., Ltd.

Model	Type	Engine Size	Measured Sound Power	Guaranteed Sound Power	Engine Output
HYEA5200X	Earth Auger	51.7cc	106.28dB(A)	107dB(A)	1.45kW

Product Details:

Brand: Hyundai

Model: HYEA5200X

Description: Petrol Earth Auger

Name and address of technical documentation holder and EU distributor:

Genpower Ltd, Isaac Way, Pembroke Dock, Pembrokeshire, SA72 4RW, UK.

Signed by: 

Roland Llewellyn, Managing Director

Date: 13/04/2020

Contact Us



www.hyundaipowerproducts.co.uk



01646 687 880



aftersales@hyundaipowerproducts.co.uk

HYUNDAI

POWER PRODUCTS

Importer:
GENPOWER LTD
Isaac Way, London Road,
Pembroke Dock, UNITED KINGDOM, SA72 4RW
T: +44 (0) 1646 687 880 F: +44 (0) 1646 686 198
E: info@hyundaipowerproducts.co.uk
www.hyundaipowerproducts.co.uk

Imported/Distributed by Genpower Ltd for The United Kingdom & Ireland

Licensed by Hyundai Corporation, Korea